



unbeatable precision meets large-field laser processing

XLSCAN is a combined scan solution jointly-developed by SCANLAB and ACS Motion Control. This innovative solution enables maximum-precision processing of workpieces without size limitations.

Key Features

- Scan solution for large-field processing
- High throughput
- Market-leading accuracy
- No stitching errors
- High-dynamics processing without stage vibration
- Unlimited job duration
- Automatic laser control, e.g. Spot Distance Control (SDC)
- Capability of combining multiple software instances, stages and scan heads

XLSCAN is based on the syncAXIS control Software's novel control concept unites synchronous scan head and XY stage control with intelligent trajectory planning. XLSCAN thus delivers the highest precision of all solutions currently on the market. Maximum flexibility and enormous throughput increases are attainable by combining XLSCAN with several syncAXIS control instances, multiple stages or multi-head systems.

Typical Applications

- Large-field marking, cutting and engraving
- Processing of glass and foils
- Micromachining
- Drilling of large-area PCBs

Standard XLSCAN setup – schematic layout

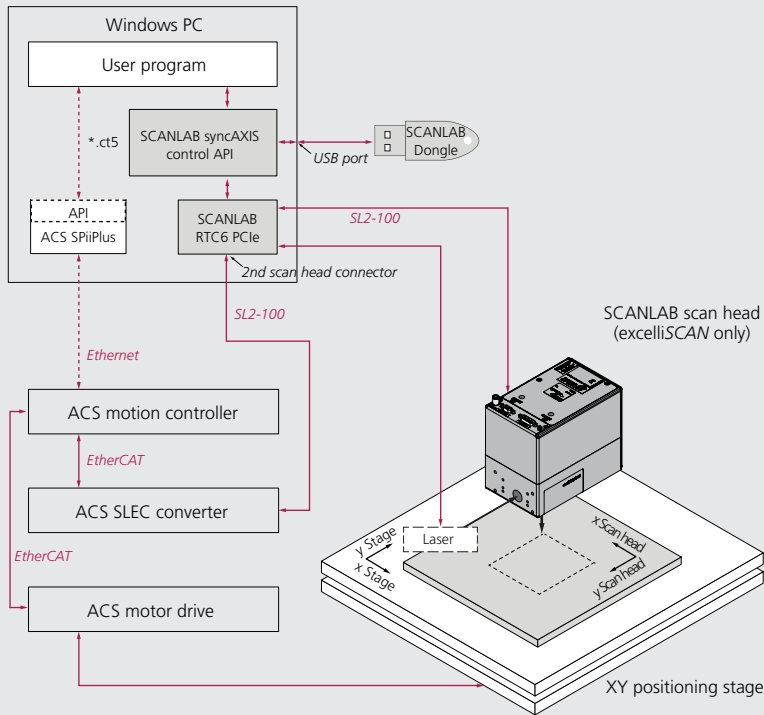

XLSCAN with 2 software instances, multiple stages and scan heads

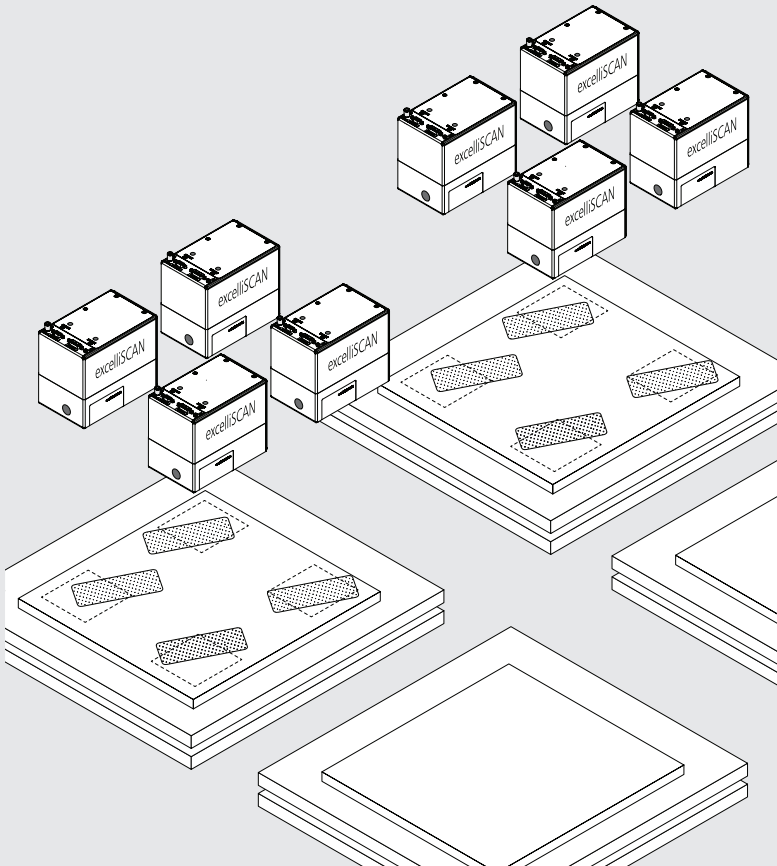

High-End Laser Processing

The schematic diagram depicts XLSCAN's system configuration. This scan solution combines SCANLAB's proven scan head control with an XY stage positioned via ACS's innovative motion control system.

The laser spot's movement across the workpiece is automatically split between the scan head and XY stage, thus assuring optimal utilization of the entire system's available dynamics. The scan head is responsible for short rapid motions, while the stage extends the working surface.

Typical System Components

SCANLAB

- syncAXIS control software package for extended image field processing.
- RTC6 PCIe (not Ethernet) control board with SCANahead and syncAXIS option
- excelliSCAN 14 high-end scan head

ACS

- ACS Controller controls stage motion and EtherCAT network
- ACS drives adapted to system requirements
- SLEC interface between RTC6 PCIe control board and ACS EtherCAT network
ACS components must be specified in accordance with your system's requirements – contact ACS Motion Control.

Components from external suppliers

- XY stage
- Laser

Additional Options

- Multiple stages, syncAXIS control instances and scan heads

Unlimited Process Area

Until now, a scan head's image field typically limited the working area's size during laser processing. Conventional methods of handling very large workpieces are slow, due to their section-wise (tiled) processing. XLSCAN enables limitless extension of working fields, bounded only by the employed mechanical axes' traversal range.

High Accuracy

excelliSCAN scan heads used in XLSCAN produce no tracking error. The syncAXIS control software's trajectory planning calculates in advance the control of stage and scan head. The scan head has no need to compensate positional deviations of the stage. Thus maximum system inaccuracy is defined solely by the sum of the scan head's and stage's combined static positioning errors.

Moreover, an advanced servo control algorithm prevents errors from workpiece vibration caused by highly dynamic stage motions.

Increased Throughput

In many applications, controlling the scan head and XY stage synchronously can significantly slash laser process times (see figure 1): The throughput for small circular markings increased by 41%. Throughput can additionally be multiplied by equipping XLSCAN with several scan heads above a stage.

No Stitching Errors

With XLSCAN, there's no longer a need for section-wise processing of large-area workpieces. Because the system enables full processing of the entire pattern, no stitching errors will occur (i.e. marking imprecision near image field borders, see figure 2).

Fast Circular Marking

Large detail-rich patterns can be created with maximum efficiency and accuracy. For instance, XLSCAN makes marking a finely structured circular path both easy and uncomplicated (see figure 3).

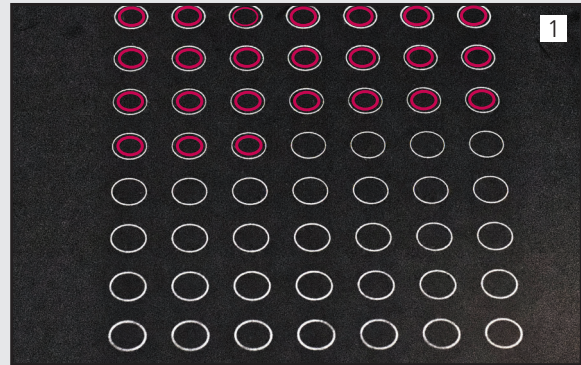

Simultaneous movement enables 41% higher throughput (the number of additionally marked circles is indicated by the red marking)



Stitching error (piecewise processing)



XLSCAN's simultaneous movement yields better processing results



Large circle with detailed marking

All user benefits are also shown in our XLSCAN video:
<https://www.scanlab.de/en/products/advanced-scanning-solutions/xl-scan>



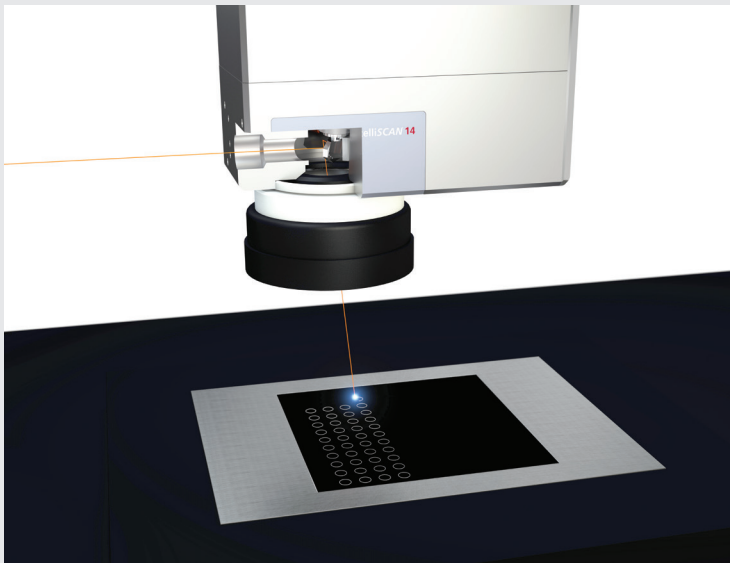

syncAXIS control software automatically splits motion paths of the scan head and stage

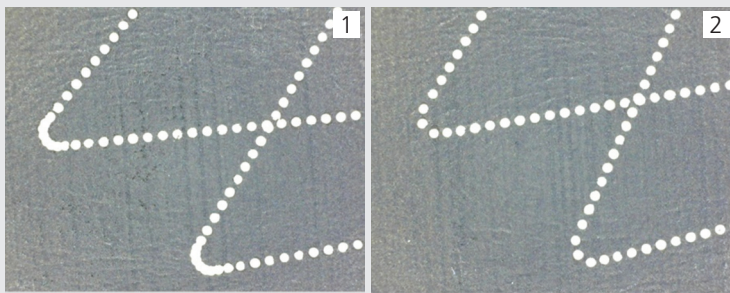

Pattern scanned without SDC function Pattern scanned with SDC function

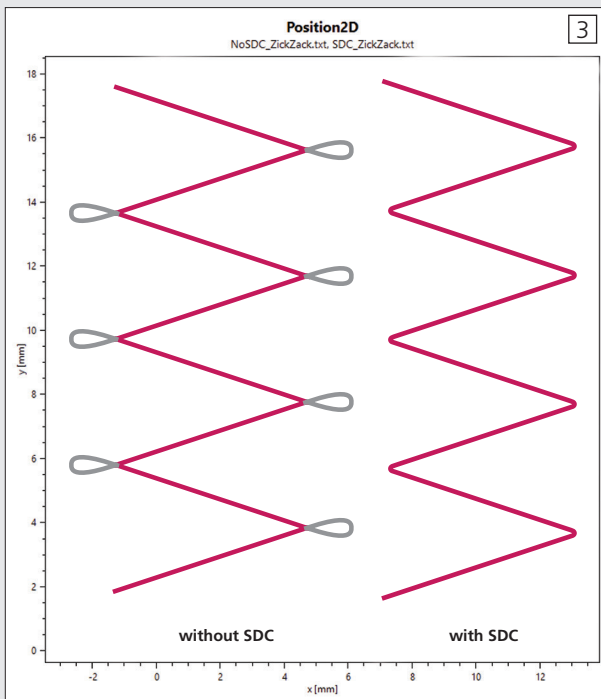

Example of time saving with zig zag line

This example shows the combined stage's and scan head's motion path for marking a zig zag line. On the left side, constant energy deposition is achieved via using sky writing. On the right side, spot distance control (SDC) function is used for constant energy deposition, even in acceleration and deceleration phases. In this example production time is reduced by 38% with SDC.

syncAXIS control Software

syncAXIS's totally new control concept eliminates the step conventional systems often require of compensating positional deviations. The software's integrated trajectory planning takes both the scan head's and the XY stage's physical limitations into account and controls them via intelligent filters. That keeps the overall system nearly tracking-error-free, resulting in XLSCAN's high precision.

Many control systems on the market compensate stage motion positional deviations by adjusting the scan head position. This induces tracking errors that limit accuracy, particularly during fast jerky stage movements.

Trajectory Planning supports Smart Laser Control

The syncAXIS control software's integrated trajectory planning enables straightforward control of modern USP lasers, too. Users can define the laser spot's pulse spacing and energy densities, as well as tolerable corner rounding. And users can configure detailed execution of process patterns.

Look-ahead trajectory planning also fully exploits the system's maximum dynamics capabilities – within user-specified tolerances. Complex-laser-path planning minimizes the laser-off times (e.g. during sky-writing) and boosts effective throughput.

Spot Distance Control (SDC)

SCANLAB's latest innovation is Spot Distance Control (SDC), an RTC6 PCIe control board function included in the XLSCAN package.

A signal to the laser control triggers a laser pulse or pulse train. For each clock period, the SDC determines with a resolution of 64 MHz whether a pulse must be emitted to maintain the desired pulse spacing. With laser frequencies between 200 and 800 kHz, a maximum pulse distance deviation of 2.5% is achievable.

Contour-Dependent Laser Control

The SDC function maintains constant pulse spacing regardless of the scan pattern. This constant distance can be aligned either along the centerline of the laser pulses or tangential to the workpiece's side. The result is uniform workpiece edges (see figures 1 and 2). Even on sensitive materials, inhomogeneities and burn-ins are avoided.

Flexible Alteration of the Laser Signal

The laser signal can be raised or attenuated in accordance with application requirements. This applies to straight as well as rounded laser markings. Even multiple parameter changes and jumps for individual vectors are possible. Figure 3 shows an example of flexibly changing the laser power.

Deflection-Angle-Dependent Control of Laser Signals

The laser's spot size at the workpiece depends on the laser beam's deflection angle through the scan head. syncAXIS control's ability to regulate laser parameters based on the deflection angle enables the spot's energy density to be held constant, even though the spot size varies minimally along the laser path (see figure 4). This function can be applied to any laser control signal.

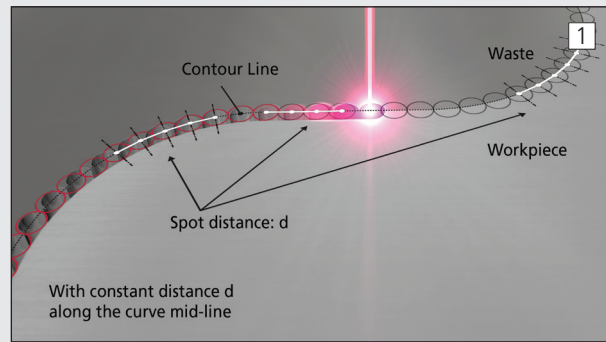

SDC: Constant distance of center of laser pulses

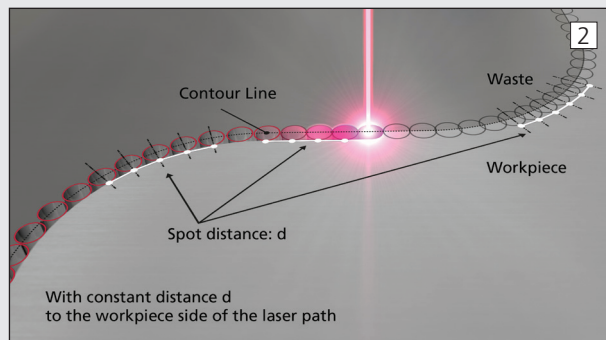

SDC: Constant distance of laser pulse along workpiece side

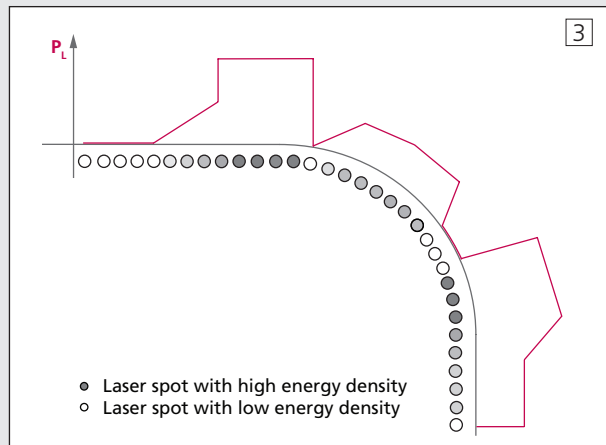

Flexible alteration of laser power signal



Deflection angle-dependent energy density

a) without automatic laser control

b) with automatic laser control

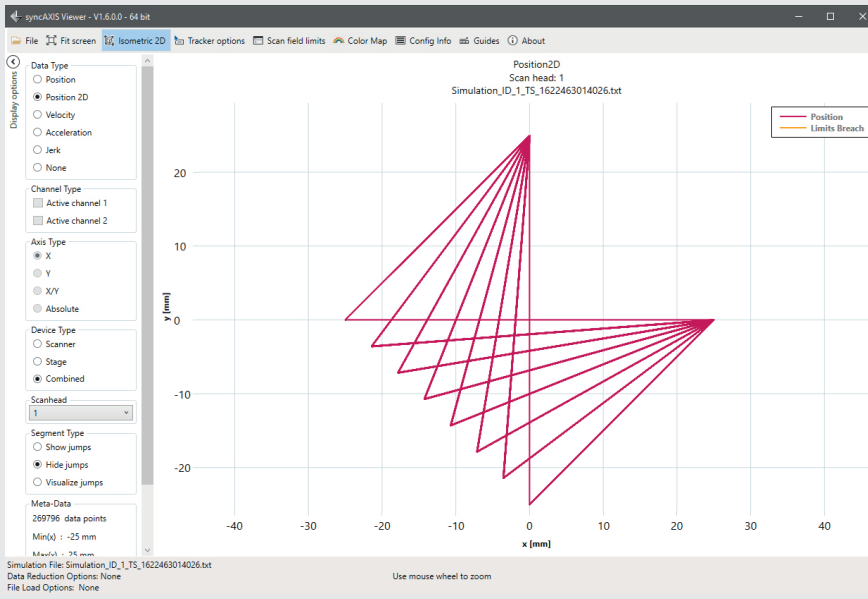

GUI of syncAXIS Viewer

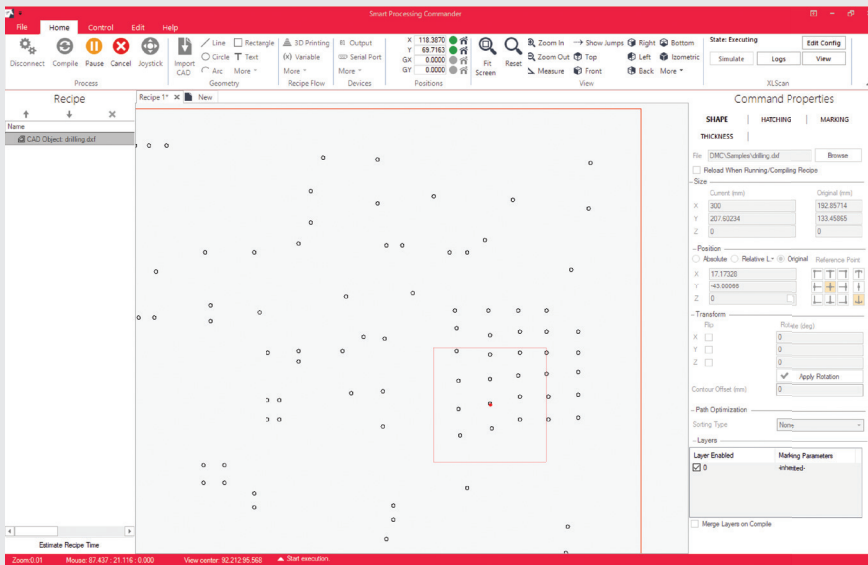

Optional GUI for XLSCAN: SPiiPlusSPC

syncAXIS Control's Benefits

- Highest precision and automatic laser control by exact trajectory planning
- Integrated Spot Distance Control (SDC)
- Straightforward job planning
- Logging mechanism for simplified troubleshooting

Programming and Simulation

User applications for XLSCAN are based on the syncAXIS control programming interface and can be developed using a dynamic link library (DLL). Its functions enable the definition, loading and execution of process jobs, as well as system parameter configuration, status monitoring and usage of callback event functions.

System initialization is achieved by simply calling a function that loads a previously defined configuration file.

Simulation Mode and Viewer

The program offers a **simulation mode** to let you establish the ideal combination of accuracy and process speed, even without connecting to hardware. The syncAXIS Viewer facilitates evaluation of simulation results and displays the scan head's and XY stage's positional and dynamics values, as well as the laser control signals.

syncAXIS Configurator

Parameters can be easily adjusted in the syncAXIS Configurator. And programming is simplified thanks to automatic RTC list handling. As soon as a configuration file is correctly defined, users will no longer need to account for list memory limitations.

The syncAXIS control Software's **logging mechanism** enables simple and efficient troubleshooting.

Intuitive User Interface

An optional graphical user interface (GUI) SPiiPlusSPC is available for controlling XLSCAN. It lets you draw laser paths or import them from CAD drawings. As needed, the software opens the syncAXIS Configurator, where you can enter trajectory parameters or load simulation files at the click of a button.

Stitch and Scan

Stitch-and-scan is the conventional method for 2D-processing of large workpieces, whereby the scan head and XY stage move separately from another. The workpiece surface is tiled into smaller sections of equal size that can fit within the scan head's image field. Laser processing of all sections occurs via the scan head while the stage remains motionless. The XY stage only moves to position the next section into the scan head's image field.

- Separate motions of the scan head and XY stage
- Low-budget solution possible with any SCANLAB scan head
- Supported by laserDESK (SCANLAB's professional software for laser material processing; incl. GUI)

2D Processing-on-the-fly

With Processing-on-the-fly the scan head and the XY stage move simultaneously. The user programs the XY stage's path in advance. When processing with on-the-fly mode, the RTC6 PCIe control board subtracts stage motion from the overall motion and then calculates the remaining path for the scan head. A temporal offset between the stage and scan head reduces accuracy during the stage's acceleration and braking movements.

- Simultaneous motion of scan head and XY stage
- Motion path for laser and XY stage has to be programmed separately

XLSCAN

XLSCAN's syncAXIS control software automatically splits the laser's motion path into an XY stage path and a scan head path. Both of these components are perfectly synchronized and the laser is likewise triggered synchronously. The user defines path-distribution parameters in accordance with the application's emphasis on accuracy or throughput. A simulation mode displays both the XY stage's and scan head's individual positions and dynamics, thus facilitating optimal utilization of the scan head and stage. This solution is particularly beneficial for OEMs, who produce high volumes of the same pattern.

- Synchronized motion of scan head and XY stage
- Automatic splitting of laser path motion
- Laser's motion path has to be programmed in advance by the user
- Unique solution by SCANLAB and ACS Motion Control

Overview of selected large field scanning solutions (with scan system and XY stage):

Solution	Flexibility	Throughput	Accuracy	GUI	Applications
Stitch and Scan	++	o	+	Yes	Frequently-changing marking applications
2D Processing on-the-fly	-	++	o	Yes	Similar patterns produced in large quantities
XLSCAN	o	++	++	Optional	Similar patterns produced in large quantities and with high accuracy

(++ excellent, + good; O moderate, - poor)

Specifications for excelliSCAN 14 with XLSCAN

Dynamics

Aperture [mm]	14
Tuning	universal
Focussing optic	F-Theta objective
Field of View	depending on objective
Tuning	universal
Tracking error [ms]	0
Typical speeds ⁽¹⁾	
Positioning, jump & shoot [m/s]	< 30
Line scan / raster scan [m/s]	< 30
Typical vector marking [m/s]	< 4
Good writing quality [cps]	1000
High writing quality [cps]	850
Positioning times ⁽¹⁾	
1 mm jump width [ms]	0.28
10 mm jump width [ms]	0.88
100 mm jump width [ms]	3.70
Acceleration [m/s ²]	51 000 ^{(1),(2)}

⁽¹⁾ with F-Theta objective, f = 160 mm

⁽²⁾ this corresponds to an angular acceleration of $3.2 \cdot 10^5$ rad/s²

Precision & Stability

Repeatability (RMS) [μrad]	< 0.4
Positioning resolution [bit]	20 ⁽⁵⁾
Nonlinearity	< 0.5 mrad / 44°
Long-term drift ^{(3),(4)}	
8-h-drift (after 30 min warm-up)	
Offset [μrad]	< 20
Gain [ppm]	< 20
24-h-drift (after 3 h warm-up)	
Offset [μrad]	< 20
Gain [ppm]	< 25
Temperature drift ⁽⁴⁾	
Offset [μrad/K]	< 10
Gain [ppm/K]	< 4

⁽³⁾ at constant ambient temperature and load

⁽⁴⁾ with water cooling

⁽⁵⁾ based on the full angle range (e.g. positioning resolution 0.7 μrad for angle range ± 0.36 rad)

Further Specifications

Optical performance	
Typical scan angle [rad]	±0.35
Gain error [mrad]	< 5
Zero offset [mrad]	< 5
Interface	SL2-100
Operating temperature [°C]	25 ± 10
Weight [kg]	approx. 7
Housing options	Air- and water cooling
Wavelengths [nm]	355, 532, 1064 and others
Power requirements	30 V DC, max. 3 A

(all angles are in optical degrees)



ACS Motion Control is a global company providing EtherCAT network based high performance machine control systems for motion centric applications. Since 1985, ACS Motion Control has provided state of the art control solutions to world leading manufacturers.

ACS Motion Control · 1 Ha-Ta'asiya St. · Ramat Gabriel Industrial Park · P.O. Box 984
Migdal Ha-Emek 2307037 · ISRAEL
Tel. +(972) 4 6546-440 · Fax +(972) 4 6546-443
info@acsmotioncontrol.com · www.acsmotioncontrol.com



With over 35,000 systems produced annually, SCANLAB GmbH is the world-leading and independent OEM manufacturer of scan solutions for deflecting and positioning laser beams in three dimensions.

SCANLAB GmbH · Siemensstr. 2a · 82178 Puchheim · Germany
Tel. +49 (89) 800 746-0 · Fax +49 (89) 800 746-199
info@scanlab.de · www.scanlab.de

SCANLAB America, Inc. · 100 Illinois St · St. Charles, IL 60174 · USA
Tel. +1 (630) 797-2044 · Fax +1 (630) 797-2001
info@scanlab-america.com · www.scanlab-america.com